

FIBERRECV20
IC???

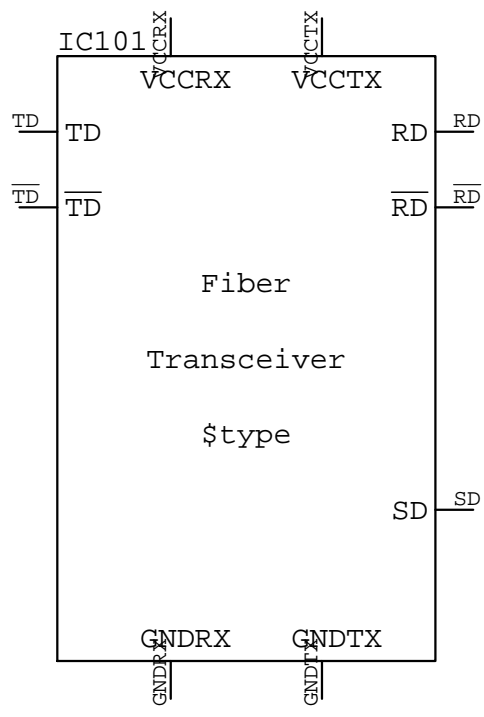

FIBERTRANSCEIVER_1X9
IC???

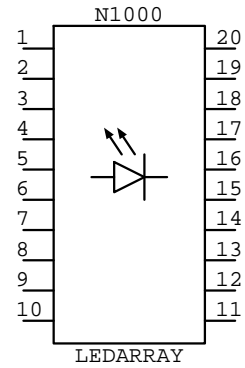
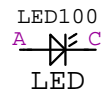
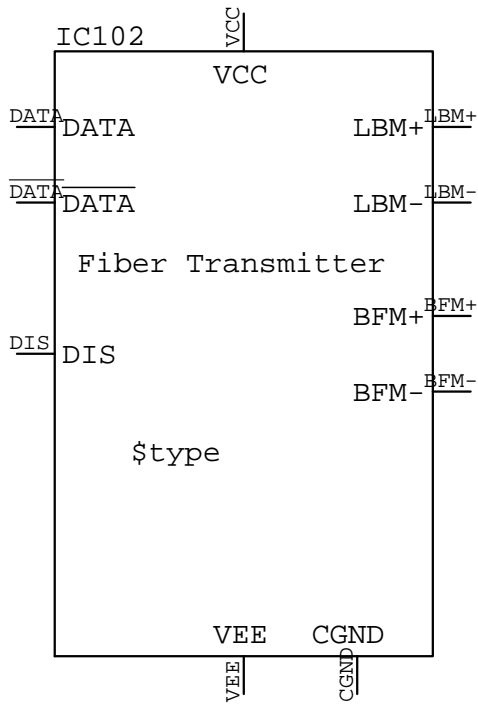

FIBERXMIT20
IC????

IRLED
DL????

LED
LED????

LEDARRAY
N?????

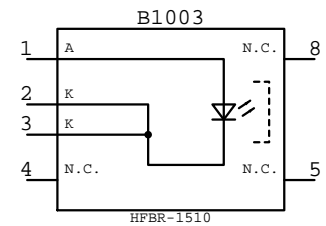
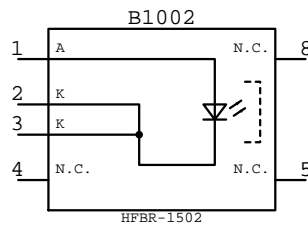
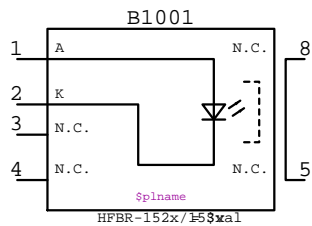
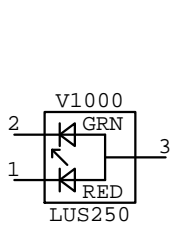

LUS250
V?????

LW_HFBR152X
B?????

LW_HFBR1502
B?????

LW_HFBR1510
B?????

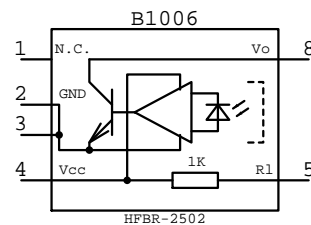
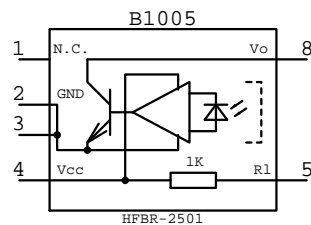
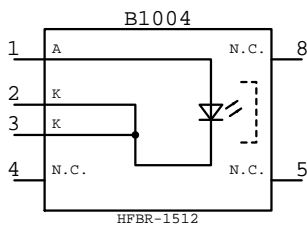

LW_HFBR1512
B?????

LW_HFBR2501
B?????

LW_HFBR2502
B?????

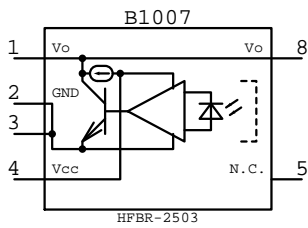

LW_HFBR2503
B?????

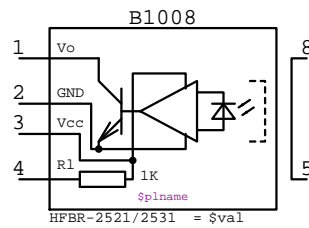

LW_HFBR2521
B?????

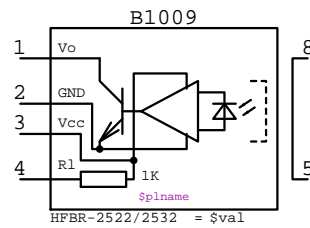

LW_HFBR2522
B?????

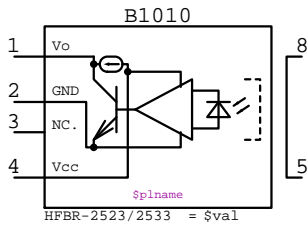

LW_HFBR2523
B?????

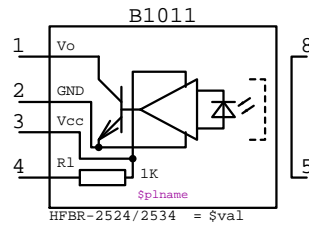

LW_HFBR2524
B?????

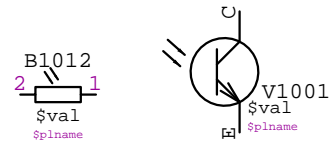

RLDR_ TR_MRD701
B????? V?????

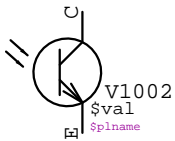

TRBNF_
V?????

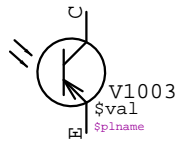

TRBPF_
V?????

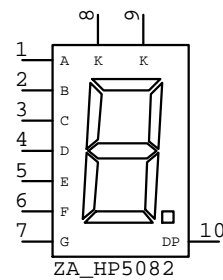

ZA_HP5082
N?????

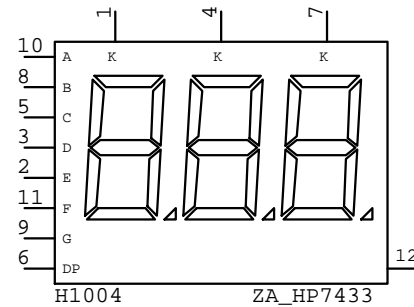

ZA_HP7433
H?????

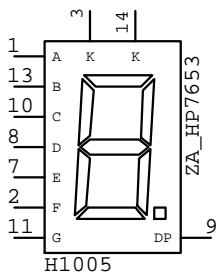

ZA_HP7653
H?????

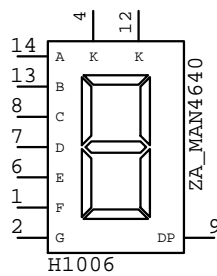

ZA_MAN4640
H?????